

Sistema Antijammer

Seguridad Automotriz

Es un Dispositivo diseñado para detectar la presencia de un Jammer o perturbador de señal celular. Una vez detectado el jammer, el dispositivo Antijammer seguirá enviando coordenadas por un lapso de 10 a 15 minutos con coordenadas validas, después de este periodo el error crece.

Protocolo Automático

Al detectar un Jammer o perturbador de señal celular, activará un protocolo de seguridad que consiste en mandar mensajes de alerta cada 2 minutos, y activa las salidas negativas para que estas puedan ser conectadas a algún Relevador de corte y así inmovilizar la unidad.

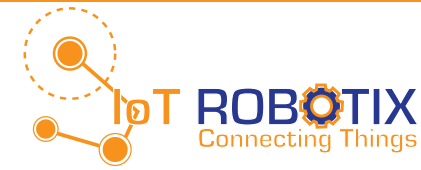

Plataforma de Rastreo Profesional

- Alertas por presencia de Jammer
- Geo-cercas
- Historico de hasta 3 años
- Reportes programables
- Alertas por email y en pantalla, sonoras
- Control de personal
- Control de documentos
- Rutas
- y muchas funciones mas...

IOTR-AJ-001

Plataforma de Rastreo

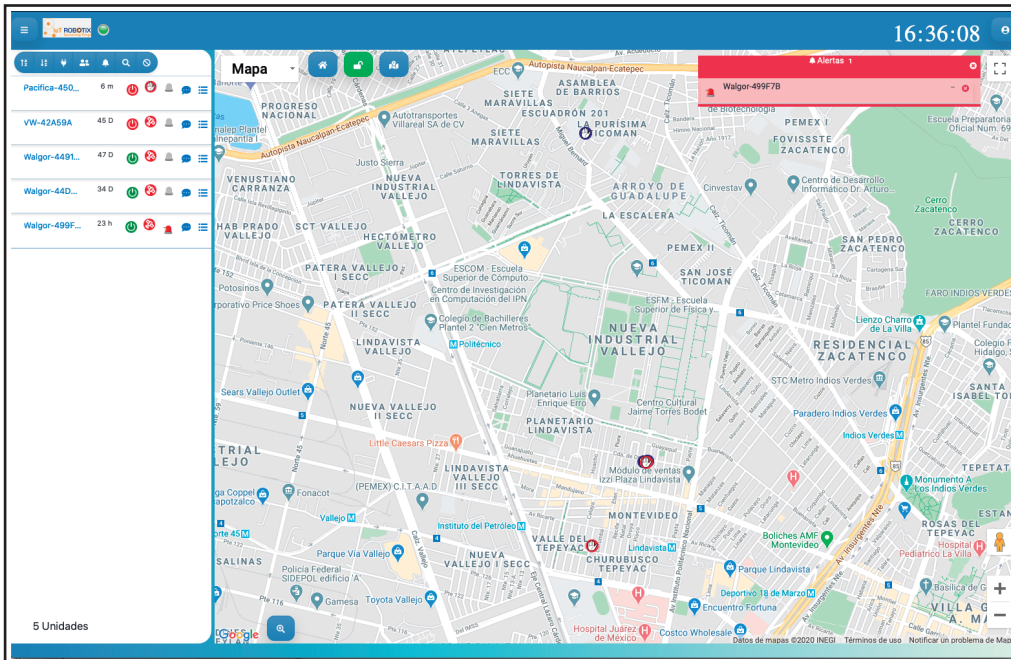

Plataforma de configuración remota

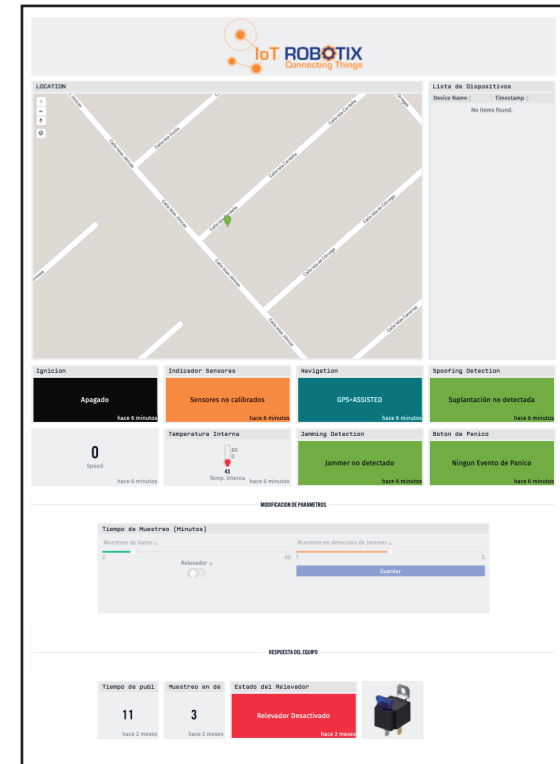



IOTR-AJ-001

IOTR-AJ-001

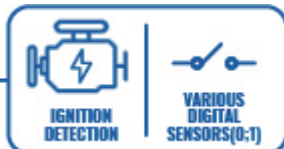

HEAVY DUTY TRANSPORT

Modern day logistics require a lot of information for business optimization, it is not enough to get ...



LIGHT VEHICLES

Main reasons for insurance pay outs are car accidents and thefts. There have been at least 7 million ...



Características:

<i>Module</i>	
Name	IOTR-AJ-001
Technology	OG / GNSS

<i>GNSS</i>	
GNSS	GPS, GLONASS, GALILEO, SBAS, QZSS, DGPS
Receiver	33 Channel
Tracking Sens.	-165 dBm
Accuracy	<3m
Hot Start	< 1 s
Warm Start	< 25 s
Cold Start	< 35 s

<i>Power</i>	
Input Voltaje range	10-30 V DC over voltage protection
Back-up Battery	300 mAh Li-ion battery, 5 hrs de autonomía

<i>Interface</i>	
Digital inputs	2
Digital Outputs	2
GNSS antenna	Active, high gain
SIGFOX antenna	High gain
Led Status	1 RGB LED, 4 state indicator

Código de colores del LED

- Verde con flasheos rapidos, SIN Coordenadas
- Verde con Flasheos lentos y espaciados, Coordenadas de navegación detectadas (FIX)
- Azul Flasheos lentos y espaciados, FIX y Sensores Calibrados
- Rojo, Presencia de Jammer detectada

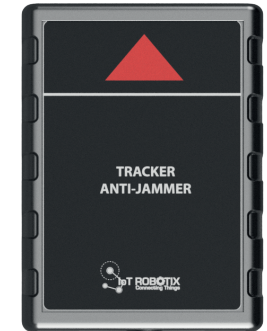

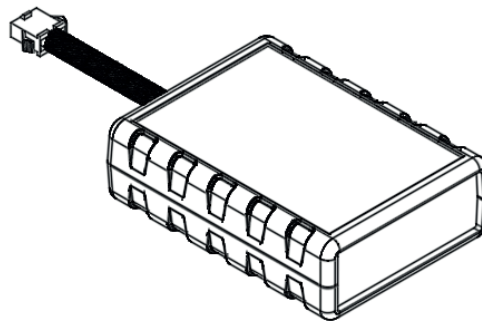
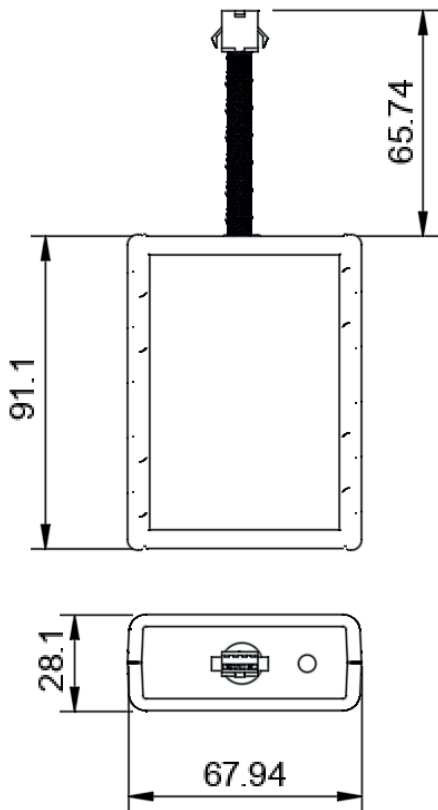

Dept. Ingenieria	Technical reference IOTR-AJ-002	Created by IOT Robotix	28/08/23	Approved by Oswaldo Angeles	
		Document type Medidas	Document status		
		Title Antijammer	DWG No. 2		
		Cotas en mm	Rev. 03	Date of issue 28-Abril-2023	Sheet 1/1